



THE NATIONAL INSURANCE INSTITUTE
BUREAU OF RESEARCH AND PLANNING

THE LABOR SUPPLY CURVE
UNDER INCOME MAINTENANCE PROGRAMS

by

Giora Hanoch and Marjorie Honig

DISCUSSION PAPERS

(In English or Hebrew as stated)

- No. 1 — "Equivalence Scales for Family Size: Findings from Israel Data", (in English) by Jack Habib and Yossi Tawil, 1974.
- No. 2 — "The Effect of Public Expenditures for Social Services on the Redistribution of Income" (in Hebrew), by Moria Avnimelech, 1974.
- No. 3 — "The Effect of Child Allowances on Fertility", (in English) by Marjorie Honig, 1974.
- No. 4 — "Poverty in Israel Before and After Receipt of Public Transfers", (in English) by Jack Habib, 1974.
- No. 5 — "Nutrition Patterns and Efficiency in Food Consumption in Israel" (in Hebrew), by Yossef Zamiri, 1974.
- No. 6 — "Changes in the System of National Insurance Contributions" (in Hebrew), by Yossi Tawil, 1974.
- No. 7 — "Redistribution through National Insurance in Israel by Income and Demographic Groups", (in English) by Jack Habib, 1975.
- No. 8 — "The Structure of the Transfer System in Israel Before and After the Devaluation of November 1974" (in Hebrew), by Marjorie Honig, Yaffa Kosloff, Efrat Bronfeld and Moti Laxer, 1975.
- No. 9 — "The Influence of Public Family Assistance for Housing on Income Distribution for Young Married Couples in 1971" (in Hebrew), by Meir Greenfeld, 1975.
- No. 10 — "Poverty in Israel in Light of the Development of the Income Maintenance System" (in Hebrew), by Jack Habib, 1976.
- No. 11 — "The Effect of Social Security Benefits on Labor Supply", (in English) by Giora Hanoch and Marjorie Honig, 1976.
- No. 12 — "Problems in the Use of Inequality Measures to Rank Income Distributions", (in Hebrew) by Yehuda Geva, 1976.
- No. 13 — "The Reform in Tax-Transfer Payments in Israel, July 1975", (in English) by Raphael Roter - Nira Shamai, 1976.
- No. 14 — "Income Tax Evasion and the Supply of Labor", (in English) by Gideon Yaniv, 1977.
- No. 15 — "A Comment on 'Labor Supply under Uncertainty: Note'" (in English), by Gideon Yaniv, 1977.
- No. 16 — "A Simultaneous Estimation of a System of Demand Equations in Israel: An Empirical Analysis, 1968-1975" (in Hebrew), by Lea Achdout, 1977.
- No. 17 — "The Supply Curve of Labor under Income Maintenance Programs" (in English), by Giora Hanoch and Marjorie Honig, 1977.

THE NATIONAL INSURANCE INSTITUTE
BUREAU OF RESEARCH AND PLANNING

THE LABOR SUPPLY CURVE
UNDER INCOME MAINTENANCE PROGRAMS

by

Giora Hanoch and Marjorie Honig

The authors are, respectively, Associate Professor of Economics, The Hebrew University, and Director, Division of Basic Research, Bureau of Research and Planning, National Insurance Institute.

ABSTRACT

The paper is a theoretical analysis of the supply curve of labor under the particular non-linear budget constraint arising from earnings-tested income maintenance programs. The joint effects of the income benefit, the implicit tax on earnings and the earnings disregard are analyzed, demonstrating that the individual supply curve must have a backward-bending section and a discontinuity; that changes in the tax above some critical rate have no effect on labor supply, and that the aggregate effect of a reduction in the tax below the critical rate is ambiguous. In the absence of an earnings disregard, the benefit may constitute a fixed cost of labor force participation, causing a higher reservation wage and a discontinuity of supply at that wage.

The paper is a revised version of an earlier paper, *The Effect of Social Security Benefits on Labor Supply* (National Insurance Institute, Jerusalem, Discussion Paper 11, May 1976).

I. INTRODUCTION

Considerable effort has been devoted in recent years to analysis of the labor supply effects of various current or proposed income maintenance programs. There have been numerous econometric studies as well as several large-scale experiments to estimate the effects on labor supply of a guaranteed minimum income combined with a tax on earnings. Curiously, in all these a basic element in labor supply analysis--the form of the individual supply curve--has been neglected. The failure to consider explicitly the particular form of the supply function may have resulted in non-negligible biases in empirical estimations and possibly in poor program design in several income maintenance schemes.

The provision of an income benefit and an implicit tax on earnings creates a nonlinear budget constraint. This implies in turn a segmented labor supply curve which must be defined separately for each wage interval corresponding to each of several cases. Empirically, a supply curve of this form requires the separate treatment of individuals on the various segments. A simple supply function which includes the implicit tax rate and the income guarantee is not appropriate in this case. Moreover, the endogeneity of the individual's position on the supply curve must be treated. Individuals (or families) choose to participate or not in an income maintenance program by adjusting their labor force behavior and their earnings. This selection process introduces a bias into the

estimations unless explicitly recognized.¹

This paper presents a theoretical analysis of labor supply when the individual is assumed to maximize utility subject to the particular nonlinear budget constraint arising from earnings-tested income maintenance programs. The joint effects of the benefit, the earnings disregard, and the implicit tax on earnings are analyzed, demonstrating that the individual supply curve must have a backward-bending section and a discontinuity. One of the implications of a curve of this form is that the aggregate labor supply effects of a reduction in the implicit tax rate are ambiguous. While current recipients may increase their hours of work because of higher after-tax wages, those who had formerly opted to forego benefits under the higher tax may reduce their labor supply in order to receive some benefits under the lower rate. These conclusions are important in light of the tendency in recent years to reduce tax rates in various income maintenance programs, primarily due to labor supply considerations. The implicit tax in the U.S. Aid to Families with Dependent Children program, the largest public assistance program, was reduced from 100% to 67%, and the implicit tax in the U.S. Social Security retirement test was reduced from 100% to a two-tiered system of 50% and 100%, and later to a single rate of 50%. The 1975 U.S. Advisory Council on Social Security, moreover, has recommended a further reduction in the rate.

The paper demonstrates in addition that reductions of the implicit tax in the range above a critical tax rate leave the supply of labor unchanged, and that, in the absence of an earnings disregard, the income benefit may constitute a fixed cost of labor force participation, causing a higher reservation wage and a discontinuity of supply at this wage, for tax rates above the critical rate.

The present analysis uses the static optimization model of leisure and goods for a single consumer. Extensions of the model to include intra-family effects and life-cycle considerations (which may be important in some age-related income maintenance programs, such as those providing retirement benefits) are not explicitly treated here, but can be developed along similar lines. This analysis may also be used to examine labor supply and participation effects of changes in program parameters other than the implicit tax rate, such as the levels of the income benefit and the earnings disregard.

Empirical methods for dealing with the implications of the theoretical labor supply curve analyzed herein will be presented in a separate paper.

II. THE MODEL

The following definitions and assumptions are adopted:

B = income benefit

M = earnings disregard, i.e., the maximum earnings allowed before reductions in benefits

X = consumption (other than leisure), measured in units of money

t = the implicit tax rate on earnings, where $0 \leq t \leq 1$

W = hourly wage rate (assumed given and independent of hours worked)²

T = maximum number of available hours

L = hours of leisure

H = hours of work

The individual's utility function is $U(X,L) = U(X, T-H)$, which is assumed to have the usual properties, with both X and L normal goods.

In the absence of an income maintenance program, the conditions for optimality for given wage \bar{W} and non-wage income \bar{Y} , are:³

$$X = \bar{Y} + \bar{W}H$$

(1)

$$\frac{\partial U / \partial L}{\partial U / \partial X} = \bar{W}$$

Conditions (1) yield the (normal) supply of labor (for wages above the reservation wage):

$$H^*(\bar{W}, \bar{Y}), \text{ satisfying } H^* > 0, \frac{\partial H^*}{\partial \bar{Y}} < 0, \text{ and } \frac{\partial H^*}{\partial \bar{W}} > 0 \text{ by assumption.}^4$$

The indirect utility function $U^*(\bar{W}, \bar{Y})$ is the corresponding maximum level of utility, i.e.,

$$U^*(\bar{W}, \bar{Y}) = U [\bar{W}H^*(\bar{W}, \bar{Y}) + \bar{Y}, T - H^*(\bar{W}, \bar{Y})], \quad (2)$$

$$U^* \text{ satisfying: } \frac{\partial U^*}{\partial \bar{W}} > 0; \frac{\partial U^*}{\partial \bar{Y}} > 0; \frac{\partial U^*}{\partial \bar{W}} / \frac{\partial U^*}{\partial \bar{Y}} = H^*.^5$$

Under an income maintenance program with benefit B , earnings maximum M , implicit tax t , and zero other non-wage income (by assumption), the budget constraint becomes segmented (Figure 1), such that:

$$X = \begin{cases} \text{(a)} & WH + B, \text{ for } WH \leq M \text{ (case 2 in Fig. 1)} \\ \text{(b)} & WH + B - t(WH - M) = (1-t)WH + (tM + B), \\ & \text{for } M \leq WH \leq M + \frac{B}{t} \text{ (i.e., } 0 \leq t(WH - M) \leq B) \\ & \text{(case 4 in Fig. 1)} \\ \text{(c)} & WH, \text{ for } WH \geq M + \frac{B}{t} \text{ (case 5 in Fig. 1)} \end{cases}$$

(b) implies that we may view the individual whose earnings are in the range where the implicit tax is effective as having a wage of $W(1-t)$ and non-wage income = $tM + B$. The budget constraint may be summarized as follows:

$$X = WH + \text{Max} [0, B - t \text{Max} (0, WH - M)] \quad (3)$$

The segmented budget constraint implies a segmented labor supply function of the individual and requires that the supply curve be defined separately for each wage interval corresponding to each of several cases.⁶ The critical values defining these wage intervals are found as solutions to the following five implicit equations:

$$H^*(W_1, B) = 0 \quad (4)$$

where W_1 is the reservation wage, the minimum wage at which the individual (receiving benefit B) enters the market. W_1 gives tangency between the indifference curve and the no-tax segment at $H^* = 0$ (See Figure 2).

$$H^*(W_2, B) = \frac{M}{W_2} \quad (5)$$

where W_2 is the wage which gives tangency between the indifference curve and the no-tax segment at the earnings maximum (such that $W_2H^* = M$) (See Figure 2).

FIGURE 1. The Segmented Budget Constraint Under an Income Maintenance Program

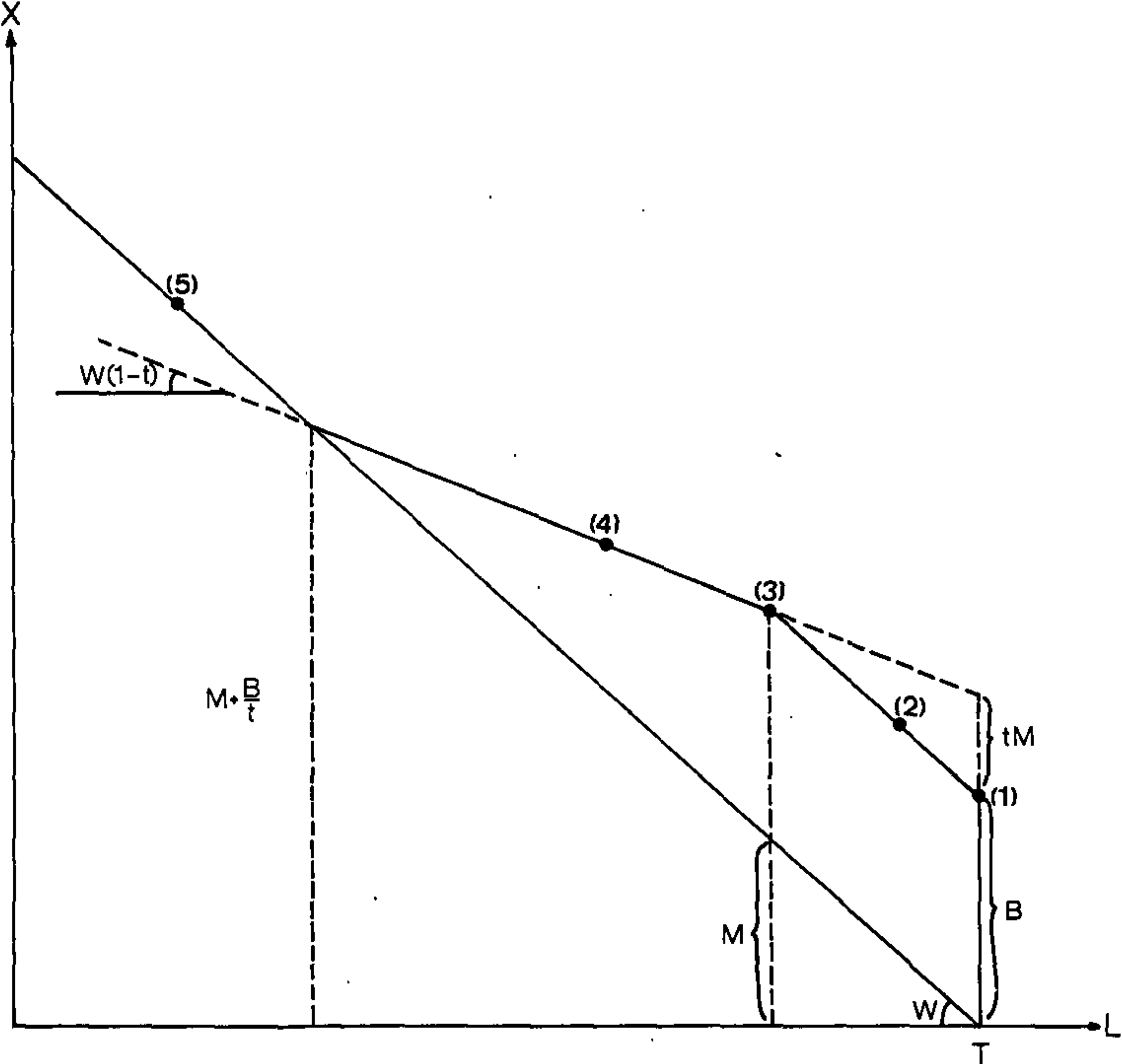
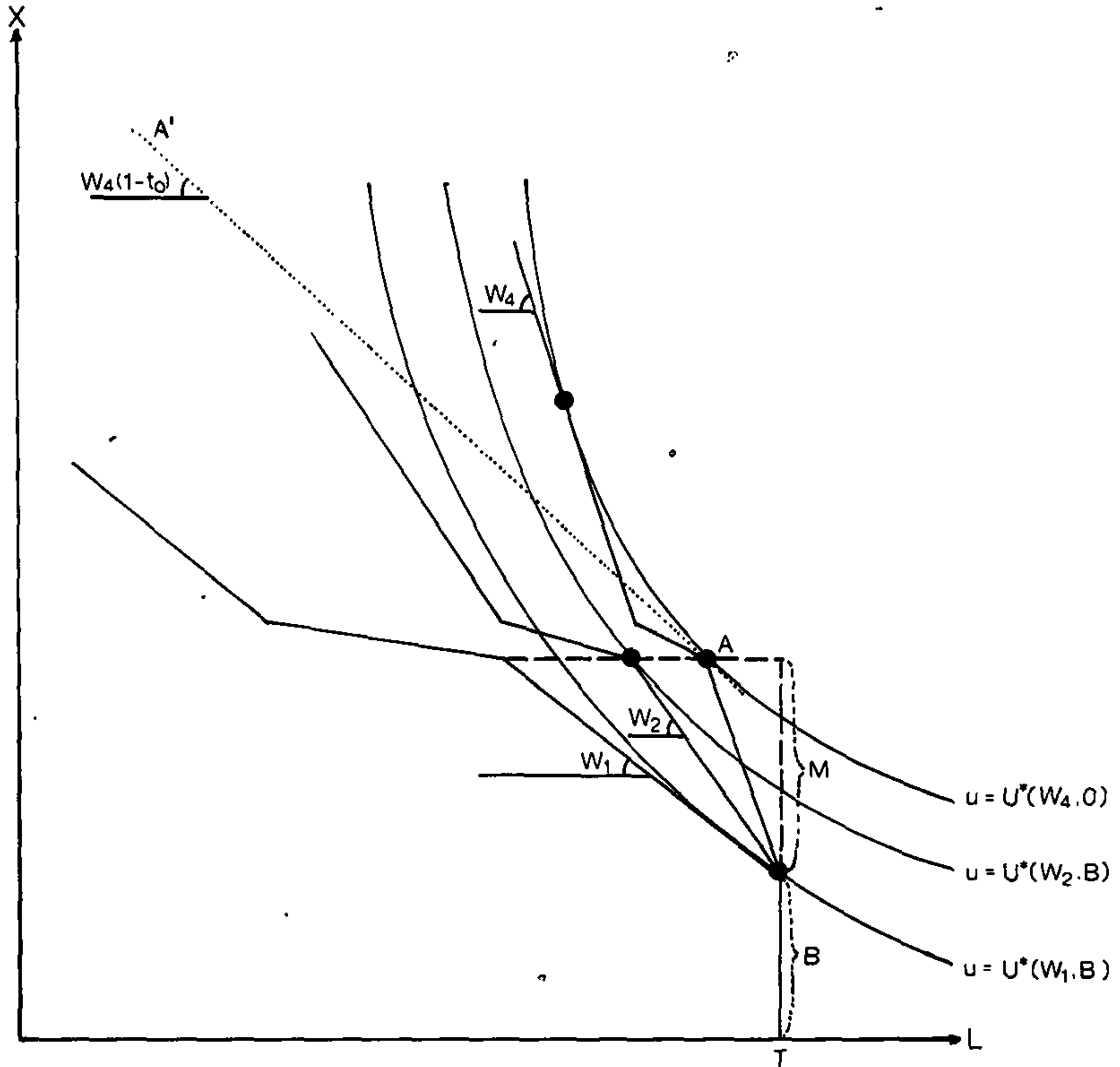

FIGURE 2. Critical Wage Rates Under $t > t_0$.



$$H^*(W_3(1-t), tM + B) = \frac{M}{W_3} \quad (6)$$

where W_3 is the wage which gives tangency between the indifference curve and the tax segment at the earnings maximum (See Figure 3). The slope of the tax segment is $W_3(1-t)$, and the individual behaves as if his non-wage income were $tM + B$ (See Figure 1).

$$U(M + B, T - \frac{M}{W_4}) = U^*(W_4, 0) \quad (7)$$

where $U^*(W_4, 0)$ is the indirect utility function (Equation 2), corresponding to $\bar{W} = W_4$ and $\bar{Y} = 0$. W_4 is the wage at which the consumer is indifferent between remaining at the corner solution corresponding to the earnings maximum, with income $M + B$ and hours of work $\frac{M}{W_4}$, or opting out of the system by foregoing the benefit B , and working $H = H^*(W, 0)$ hours, corresponding to the tangency solution on the $\bar{Y} = 0$ budget line (See Figure 2).

$$U^*(W_5(1-t), tM + B) = U^*(W_5, 0) \quad (8)$$

where W_5 is the wage at which the individual, once on the tax segment, is indifferent between remaining there or opting out of the system by working more and foregoing all benefits (See Figure 3).

FIGURE 3. Critical Wage Rates Under $t < t_0$

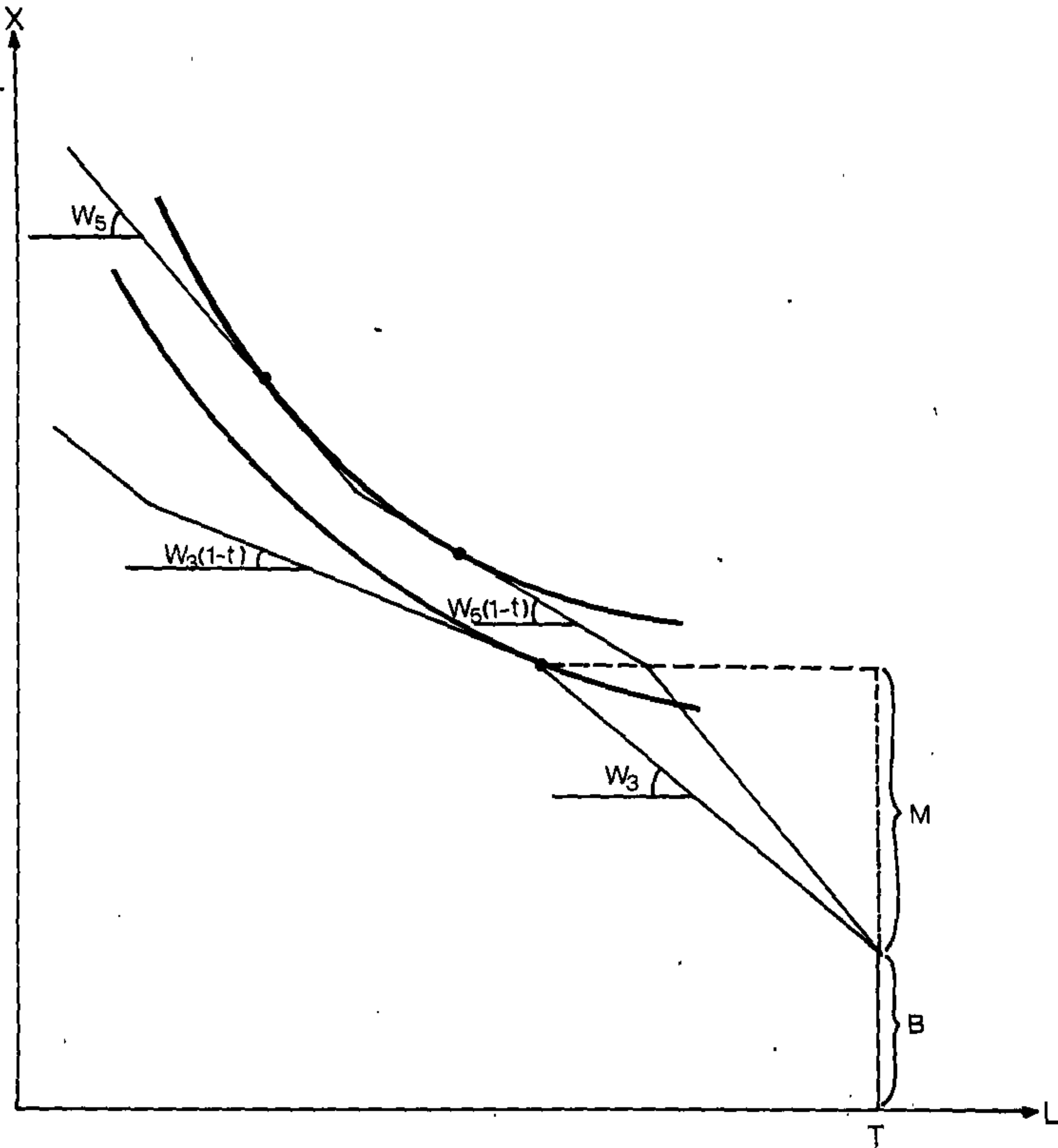

We proceed to define the supply curve over its entire range. It may be shown that: $W_1 < W_2 < W_3$; $W_2 < W_4$; $W_3 < W_4 < W_5$, for $0 < t < t_0$ (where t_0 is a critical rate such that $W_3 = W_4 = W_5$; see below, and see Appendix for proofs). It is demonstrated that the supply curve will take on two basic forms, depending on the value of t . For t greater than the critical value t_0 , the tax segment is not effective, and the individual moves directly by a discontinuous "jump" from the corner solution at the earnings maximum to a point outside of the benefits system, where he foregoes the benefit B . Wages W_3 and W_5 are not relevant in this case.

For cases where t is less than t_0 , he moves on to the tax segment from the corner at W_3 , and at some wage W_5 (higher than W_4) becomes indifferent between remaining on the tax segment, or moving out of the system, implying a discontinuity of the supply curve at W_5 .

Define $W^* = \text{Min}(W_3, W_4)$. The supply of labor is then given as follows:

	Point in Figure 1.	
$H = 0$, for $W \leq W_1$	1	(9)
$H = H^*(W, B)$, for $W_1 \leq W \leq W_2$	2	
$H = \frac{M}{W}$, for $W_2 \leq W \leq W^*$	3	

	Point in Figure 1
If $W^* = W_3 < W_4$, then	(10)
$H = H^*(W(1-t), tM + B)$, for $W^* \leq W < W_5$	4
and $H = H^*(W, 0)$, for $W > W_5$	5

If $W^* = W_4 < W_3$,	(11)
$H = H^*(W, 0)$, for $W > W^* = W_4$	5

We now determine W^* . Define t_0 as the tax rate which gives $W_3 = W_4 = W_5$. A geometric definition of t_0 is provided in Figure 2, where the dotted line AA' , which is tangent to the indifference curve $u = U^*(W_4, 0)$ at the corner A , has a slope $-\frac{\partial X}{\partial L} = W_4(1-t_0)$. Substituting W_4 in Equation (6), which defines W_3 , gives an implicit equation for t_0 :

$$H^*(W_4(1-t_0), t_0M + B) = \frac{M}{W_4} \quad (12)$$

Then it may be shown that, for $t < t_0$, $W^* = W_3 < W_4 < W_5$, and for $t > t_0$, $W^* = W_4 < W_3$. This follows since W_3 is an increasing function of t (See Appendix (i) for proof), while W_4 is independent of t . Thus, if at t_0 , $W_3 = W_4$, then for $t > t_0$, $W_3 > W_4$.

The labor supply curve is shown in Figure 4. The supply curve is initially positively sloped over the range where the effective tax

FIGURE 4. Labor Supply Curves Under an Income Maintenance Program

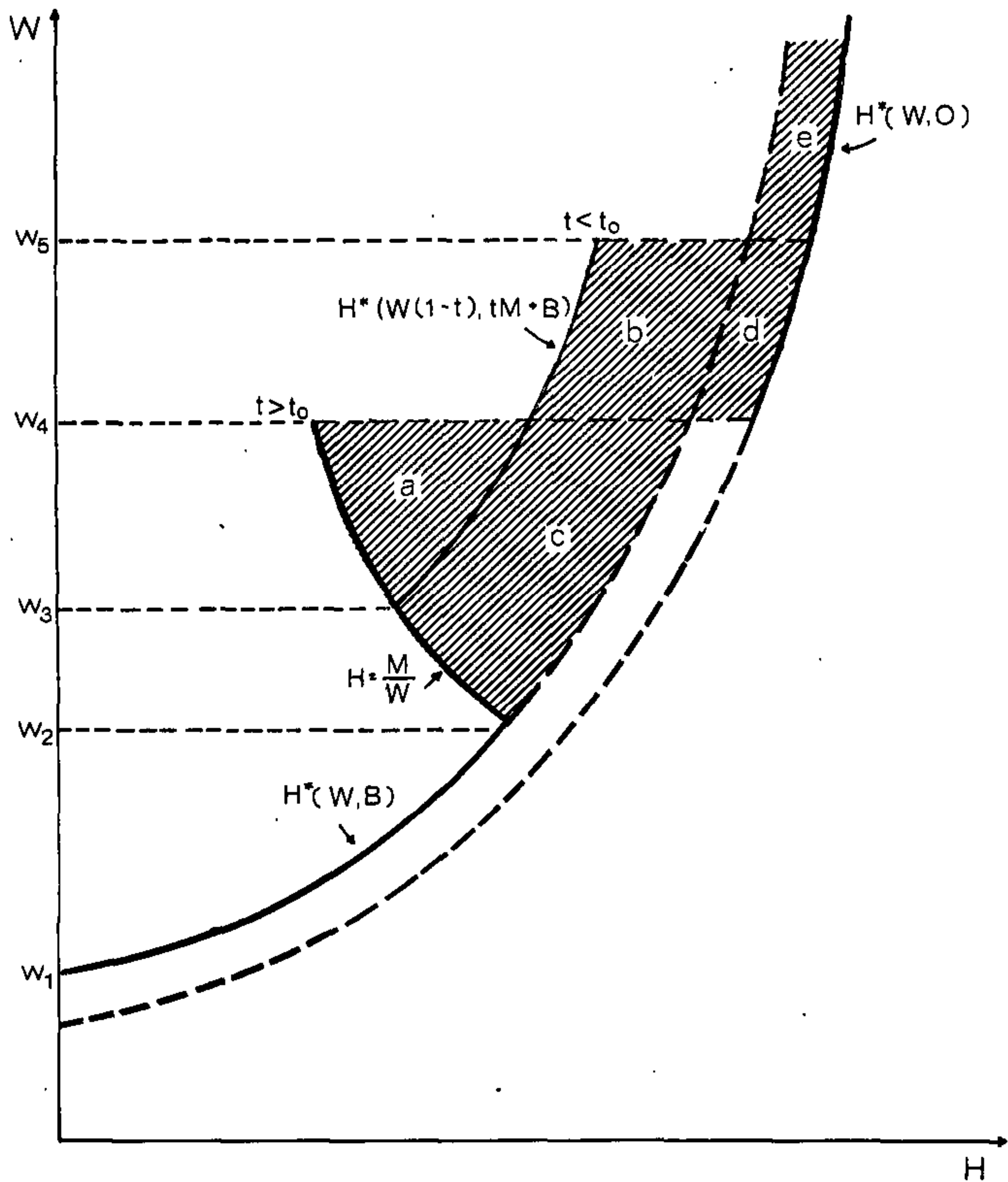

rate is zero (earnings below the maximum M); optimal hours of work are a function of the wage (higher than the reservation wage W_1) with \bar{Y} equal to the benefit B . At the corner solution wage W_2 , the supply curve bends backward and becomes a rectangular hyperbola, where earnings WH are always equal to the maximum M , corresponding to the corner solution at (3) in Figure 1. For $t > t_0$ (and thus $W_3 > W_4$), this section continues until wage W_4 , at which the individual is indifferent between remaining at the earnings maximum, or increasing his earnings above the maximum and foregoing the benefit. For wages above W_4 , he moves onto the continuation of the supply curve $H^*(W, 0)$ which would have been in effect in the absence of the program.

For $t < t_0$, such that $W_3 < W_4$, the individual moves, as his wage increases, from the earnings maximum on to the tax segment, at wage W_3 , where his labor supply is given by $H^*(W(1-t), tM + B)$. He proceeds along the tax segment until his rising wage reaches the level W_5 , at which he is indifferent between remaining on the tax segment, or opting out of the system, to the supply curve $H^*(W, 0)$.

Thus, for any income maintenance system which imposes an implicit tax on benefits for earnings over a given maximum, the supply curve exhibits both a backward-bending section and a discontinuity.

The income and tax effects of income maintenance benefits, when benefits are conditioned on earnings, are discernible from Figure 4. At any given wage, the "income effect" is measured as the horizontal distance between the upward-sloping supply curves $H^*(W,0)$ and $H^*(W,B)$, which differ only by the effect of income B (and on which $t = 0$). The "tax effect" is the horizontal distance between the actual segmented supply curve, and the "no-tax supply curve" $H^*(W, B)$.

Two implications of the model are readily apparent. The tax effect does not vary for changes in the tax rate in the range above the critical t_0 . In other words, reductions in t to a rate greater than t_0 will have no effect on labor supply.

Secondly, a reduction in the tax to a rate smaller than t_0 may lead to an increase or decrease in hours of work for the individual, depending on his wage (relative to the critical wage rates, which are influenced by his preferences as well). A decrease in the tax for those in the wage range W_3 to W_4 increases hours of work (from the corner $H = \frac{M}{W}$ to the tax segment). For a wage above W_4 but below W_5 , the individual who had foregone the benefit under $t > t_0$ now reduces his hours of work by moving along the tax segment of the supply curve (See Figure 5 below).

Thus, while both the income and wage effects of a reduction in the tax rate tend to increase labor supply for any individual who is a

FIGURE 5. An Effect of a Reduction in the Implicit Tax Rate

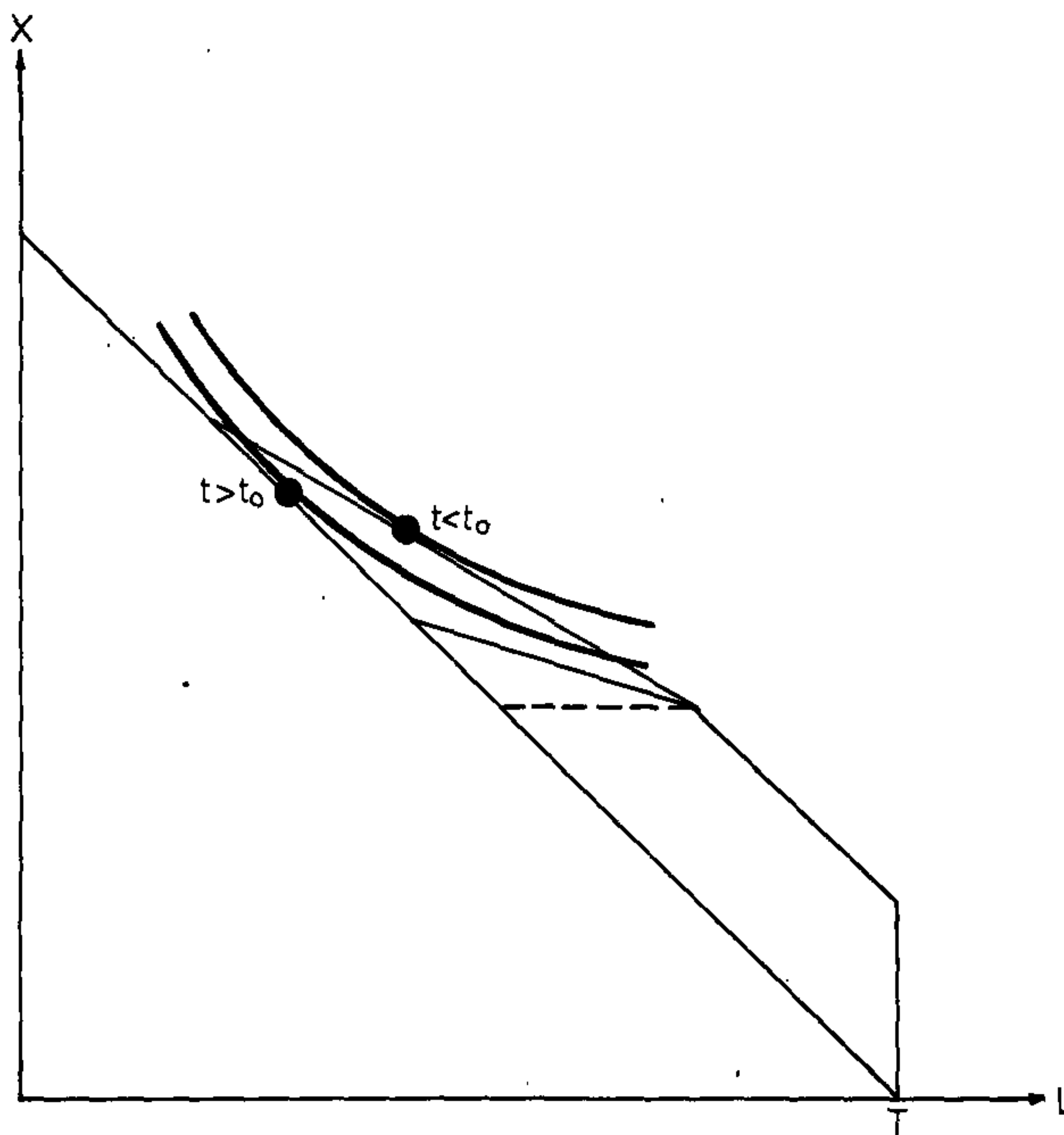

recipient of benefits, the reduction in the tax may bring into the system and reduce the labor supply of individuals who, under the higher tax, would have foregone the benefit. For these individuals, the optimal point under the reduced tax corresponds to a lower wage and a higher income than the corresponding optimal point outside of the system under the higher tax.

In the aggregate, the effect of a reduction in the implicit tax to any t below t_0 depends on the distribution of wages in the relevant wage ranges. If all individuals have the same labor supply curve, and if the wage distribution is uniform between W_3 and W_5 , then the aggregate effect of a reduction in the tax rate to t ($0 < t < t_0$), depends on the size of the area (a) relative to (b + d) in Figure 4. The effect of complete elimination of the tax, when initially $t > t_0$, depends, under similar assumptions, on the size of area (a + c) relative to (d + e); and, when initially $t < t_0$, on area (b + c) relative to (e). In other words, it is possible, and quite probable, that a reduction in the tax or its elimination may lead to a reduction rather than an increase in the aggregate labor supply.

The basic features of the model and the effect of varying t can be illustrated by use of a simple Cobb-Douglas utility function:

$$U(L, X) = L^\alpha X = (T - H)^\alpha X, \text{ where } \alpha > 0^7 \quad (13)$$

Deriving the first-order conditions for a maximum, as given in Equation (1), for the particular form (13) and solving for H yields the labor supply equation:

$$H^*(\bar{W}, \bar{Y}) = \frac{T}{1+\alpha} - \frac{\alpha}{1+\alpha} \cdot \frac{\bar{Y}}{\bar{W}} \quad (14)$$

where $\frac{\partial H^*}{\partial \bar{W}} = \frac{\alpha \bar{Y}}{(1+\alpha) \bar{W}^2} > 0$ and $\frac{\partial H^*}{\partial \bar{Y}} = -\frac{\alpha}{1+\alpha} \cdot \frac{1}{\bar{W}} < 0$

Using (14), solutions for the five wages defined implicitly in (4) - (8) can be derived. Substituting (14) into (4), (5) and (6) gives explicit solutions for W_1 , W_2 and W_3 , respectively:

$$W_1 = \frac{\alpha B}{T} \quad (15)$$

$$W_2 = \frac{\alpha B + (1+\alpha)M}{T} \quad (16)$$

$$W_3 = \frac{\alpha B + (1+\alpha-t)M}{(1-t)T} \quad (17)$$

It is easily verified that $W_3 > W_2 > W_1$. The implicit equations for W_4 and W_5 involve the indirect utility function $U^*(\bar{W}, \bar{Y})$. Substituting (14) into (13) gives, after some algebraic manipulations, the particular

form of the indirect utility function as follows:

$$U^*(\bar{W}, \bar{Y}) = \alpha^\alpha (1+\alpha)^{-(1+\alpha)} (\bar{Y} + \bar{W}T)^{1+\alpha} \bar{W}^{-\alpha} \quad (18)$$

When $\bar{Y} = 0$ and $\bar{W} = W$ (i.e., outside the benefit system), maximum utility U^* is proportional to the wage rate W :

$$U^*(W, 0) = \alpha^\alpha (1+\alpha)^{-(1+\alpha)} T^{1+\alpha} W ; \quad (19)$$

and along the tax segment, when $\bar{Y} = tM + B$ and $\bar{W} = W(1-t)$:

$$U^*(W(1-t), tM + B) = \alpha^\alpha (1+\alpha)^{-(1+\alpha)} [(1-t)WT + (tM+B)]^{1+\alpha} [W(1-t)]^{-\alpha} \quad (20)$$

Substituting (19) and (20) into (7) and (8); respectively, gives the implicit equations for W_4 and W_5 as follows:

$$(M + B) \left(T - \frac{M}{W_4}\right)^\alpha = \alpha^\alpha (1+\alpha)^{-(1+\alpha)} T^{1+\alpha} W_4 \quad (21)$$

$$[(1-t)W_5T + (tM + B)]^{1+\alpha} (W_5(1-t))^{-\alpha} = T^{1+\alpha} W_5 \quad (22)$$

Assigning values of $\alpha = 2$ and $T = 24$, and using the approximate daily values of the retirement benefit and earnings maximum in the

Social Security program in Israel as an example ($M = \text{IL } 12$ and a flat-rate benefit $B = \text{IL } 6/\text{day}$), we can simulate the supply curve of labor for those eligible for benefits and in the ages affected by the earnings test (65-70 years for males; 60-65 for females), who have zero non-wage income.⁸

The implicit tax rate in the Israeli system is 100%. The value of t_0 was computed to be $.54^9$, implying that a reduction in the 100% tax to any rate equal to or above 54% would have no effect, in this case, on the supply of labor. Hours of work for any wage rate W are found by substituting (14) into expressions (9) - (11). The supply curves are depicted in Figure 6.

The labor supply curves corresponding to tax rates below t_0 indicate that a reduction in the tax rate (from .4 to .2 in Figure 6) limits the tax effect below the opting-out wage W_5 , but increases W_5 (from 4 to 6.8), and thus reduces hours worked for wages in the range between the two levels of W_5 . The net aggregate effect, as discussed above, depends on the relative magnitudes of the two effects, as well as on the wage distribution.

We now examine the influence on labor supply of the income benefit and the implicit tax in the absence of an earnings disregard.¹⁰ For $M = 0$, the tax segment of the budget constraint begins at $H = 0$; thus W_1 and W_2 are not applicable. In the case of $t \geq t_0$, only W_4

FIGURE 6. Labor Supply Under Cobb-Douglas Utility and Various Tax Rates
(Y=0)

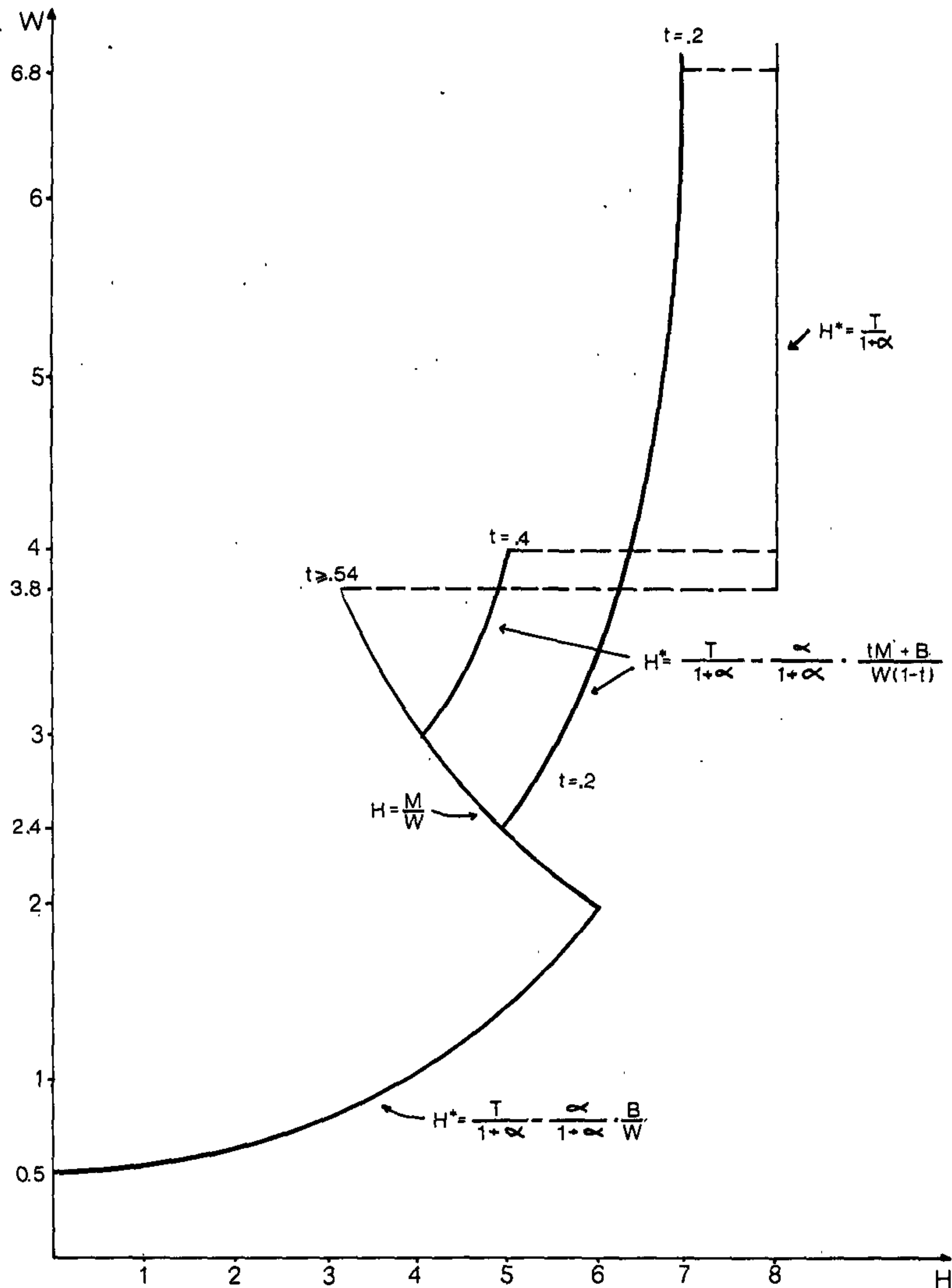

is relevant, with the implication that the amount of labor H will be either zero, or greater than a positive minimum H_0 (See Figure 7). The wage at which the individual is indifferent between being at the corner or opting out of the system is thus equal to his reservation wage W_4 . The benefit B is, in fact, never received by workers, and is accepted by non-workers only. Thus it becomes an alternative fixed cost of entry relevant to the participation decision. As has been pointed out elsewhere,¹¹ the effect of a fixed cost is to increase the reservation wage above the shadow price of time at zero hours (in this case, from W_1 to W_4), and to produce a discontinuity of the supply curve at the reservation wage.¹²

In the case of $t < t_0$, only W_3 and W_5 are relevant, and the supply curve has a discontinuity at W_5 , which is higher than wage W_3 . Again, the effect of a reduction in the implicit tax rate on aggregate labor supply is ambiguous (See Figure 7).

FIGURE 7. Labor Supply Curves under Income Maintenance Programs with Zero Earnings Disregards

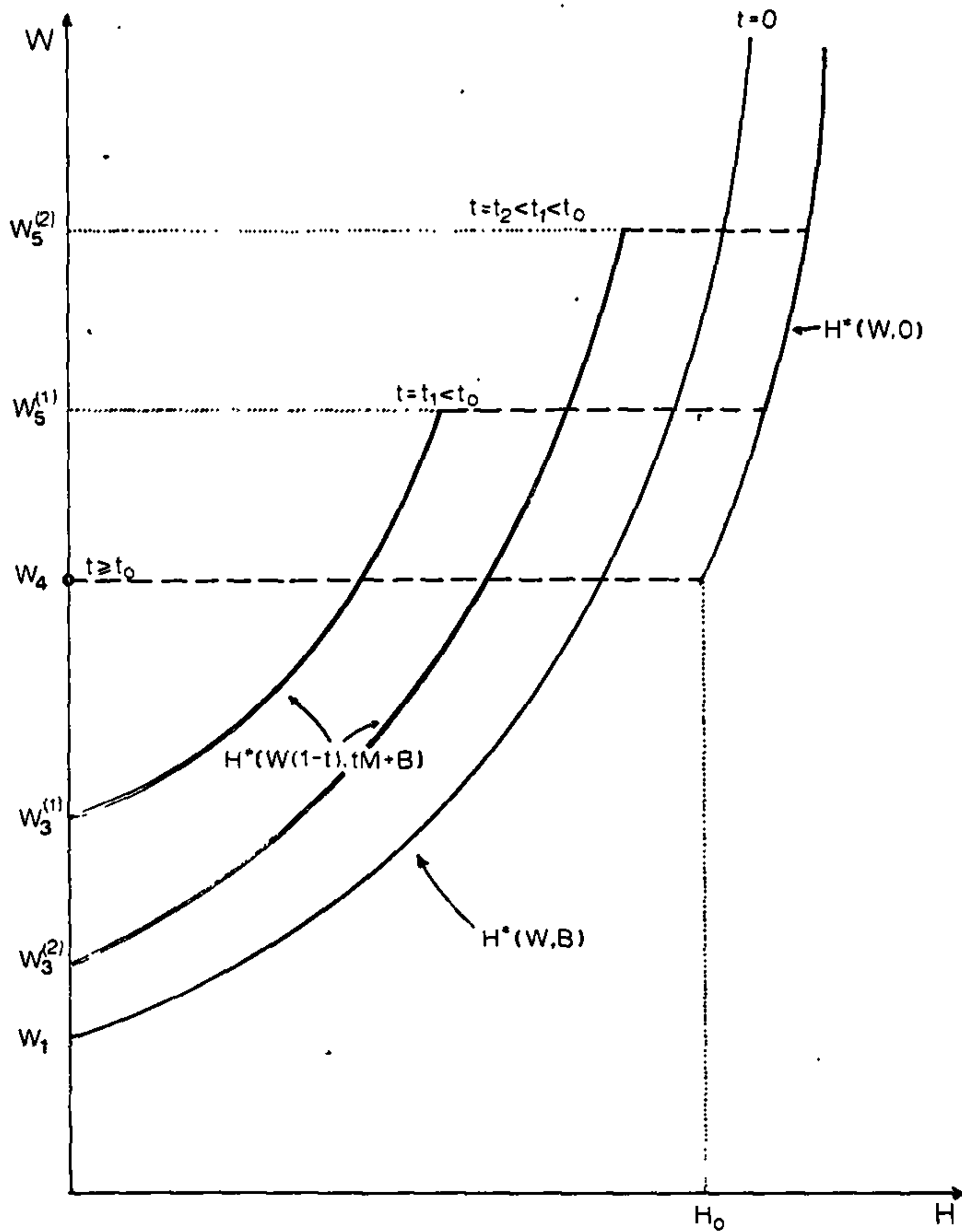

III. SUMMARY

The model presented above has been developed to analyze the effects of income maintenance programs on hours of work. The implications of both the increase in income from the program as well as the implicit tax on earnings and the earnings disregard are analyzed, and hypothetical supply curves are derived. It is demonstrated that the effect on aggregate labor supply of reductions in the implicit tax rate is ambiguous, such that reductions in the tax rate may produce a decrease rather than an increase in labor supply. Moreover, it is shown that reductions in the tax to a rate above some critical rate will have no effect on the supply of labor.

Finally, in the absence of an earnings maximum, and if the implicit tax on earnings is high, the effect of the income benefit is to reduce labor supply in a way analogous to the effect of any fixed cost associated with entry into the labor force, by increasing the reservation wage and inducing a discontinuity of supply at this wage.

The model presented above has been applied to the retirement benefits program in Israel. It is, however, applicable to any income maintenance program which contains income benefits and an implicit tax on earnings, with or without an earnings disregard, and may be applied to the various negative income tax proposals.

APPENDIX: Proofs

(i) $\frac{\partial W_3}{\partial t} > 0$:

Differentiating (6) implicitly with respect to the tax rate t gives:

$$H_1^*[(1-t) \frac{\partial W_3}{\partial t} - W_3] + H_2^*M = - \frac{M}{W_3^2} \cdot \frac{\partial W_3}{\partial t}$$

where $H_1^* = \frac{\partial H^*}{\partial (W_3(1-t))} > 0$, $H_2^* = \frac{\partial H^*}{\partial (tM+B)} < 0$, by assumption.

Solving for $\frac{\partial W_3}{\partial t}$ gives, therefore

$$\frac{\partial W_3}{\partial t} = \frac{W_3 H_1^* - M H_2^*}{(1-t)H_1^* + M/W_3^2} > 0$$

(ii) $W_1 < W_2$:

Given $H^*(W_1, B) = 0$ and $H^*(W_2, B) = \frac{M}{W_2} > 0$;

since $\frac{\partial H^*}{\partial W} > 0$, by assumption, $H^*(W_1, B) < H^*(W_2, B)$ implies $W_1 < W_2$.

(iii) $W_2 < W_3$:

Given $H^*(W_2, B) = \frac{M}{W_2}$ and $H^*(W_3(1-t), tM + B) = \frac{M}{W_3}$;

then for $t = 0$, $W_2 = W_3$. Since $\frac{\partial W_3}{\partial t} > 0$ by (i) above, and

$\frac{\partial W_2}{\partial t} = 0$, then if $t > 0$, $W_3 > W_2$.

(iv) $W_2 < W_4$:

Define $X^* = Y + \bar{W}H^*(\bar{W}, \bar{Y})$. Then $X^*(W_2, B) = M + B$ (Eq. 5),
and $X^*(W_4, 0) > M + B$ (See Fig. 2).

Therefore $X^*(W_4, 0) > X^*(W_2, B)$. But $X^*(W_2, B) > X^*(W_2, 0)$
since $\frac{\partial X^*}{\partial Y} > 0$ if X is a normal good.

Therefore, combining these results, $X^*(W_4, 0) > X^*(W_2, 0)$.

Since clearly $\frac{\partial X^*}{\partial \bar{W}} > 0$, this implies $W_4 > W_2$.

(v) If $t < t_0$, then $W_3 < W_4 < W_5$. If $t = t_0$, then $W_3 = W_4 = W_5$,
by definition. $W_3 < W_4$ for $t < t_0$ is implied by (i) above.
If $t < t_0$, then at wage W_4 the individual's optimal point is

still on the tax segment (the tax segment intersects the indifference curve $u = U^*(W_4, 0)$; see Figure 2). Hence the jump out of the system occurs at $W_5 > W_4$. (An alternative proof can be given, showing that $\frac{\partial W_5}{\partial t} < 0$).

FOOTNOTES

1. Recently, some empirical studies have taken into account these problems without explicitly recognizing the complete form of the supply function and the conditions for choice of its relevant branch. See Rea (1974), Hall (1975) and Moffitt (1977).
2. We abstract from restrictions on the demand side which may make it impossible to vary hours of work continuously at a fixed given wage. The analysis is intended to emphasize the economic factors at work on the supply side rather than the outcomes of both supply and demand factors.
3. Under the usual assumptions (of monotonicity and quasi-concavity) on the utility function, these first order conditions are not only necessary but also sufficient for an interior solution (i.e., for positive hours of work).
4. We maintain throughout the assumption of an upward-sloping supply curve, which is not unreasonable for the lower part of the wage distribution relevant to the receipt of income maintenance benefits under an earnings test.
5. For a discussion of the application of the indirect utility function to labor supply analysis, see Hanoch (1976a).

6. The segmented budget constraint precludes the use of a simple function in an empirical estimation of labor supply, since it implies discontinuities in the level and the slope of the supply curve, as well as corner solutions, as shown below. It also requires that the estimations take into account the endogenous nature of the choice of the relevant segment of the budget constraint, or the corresponding branch of the supply function. See fn. 1.

7. (13) is equivalent to a linear homogeneous utility function $U = (T - H)^\lambda X^{1-\lambda}$, where $\lambda = \frac{\alpha}{1+\alpha}$. On use of this function in labor supply, see Hanoch (1976a).

8. This example is treated more fully in Hanoch and Honig (1976). The numerical illustration of the model is carried out in units of hours per day, which may represent an average over the month or year. The values of α and T should be determined empirically and the values used above are merely illustrative. They are, however, not unreasonable. A value of $\alpha = 2$ yields the result that in the absence of income maintenance benefits and other income, the individual allocates one-third, or eight hours, of his time to work. (The inelastic supply curve is a result of the assumption of zero non-wage income. The usual upward-sloping curve appears when non-wage income Y takes on positive values, as seen in (14)).

9. Substituting W_4 for W_3 in Eq. (17) gives $W_4 = \frac{\alpha B + (1+\alpha-t_0)M}{(1-t_0)T}$,
so that the value of t_0 is given by $t_0 = 1 - \frac{\alpha(B+M)}{TW_4 - M}$.
10. While many current income maintenance programs provide for an earnings disregard, it is not a feature of most negative income tax proposals. In Israel, the retirement benefits program allows for an earnings disregard only if non-wage income is low.
11. See Cogan (1977), and Hanoch (1976a), p. 42.
12. On estimating labor supply under fixed costs of entry, see Hanoch (1976b).

REFERENCES

- Cogan, J., 1977. Labor Supply with Time and Money Costs of Entry
(The Rand Corporation, Santa Monica, R-2044-HEW).
- Hall, R.E., 1975. Effects of the Experimental Negative Income Tax on
Labor Supply, in: J.A. Pechman and P.M. Timpane, eds., Work
Incentives and Income Guarantees: The New Jersey Negative Income
Tax Experiment. (The Brookings Institution, Washington, D.C.), 115-147.
- Hanoch, G., 1976a. Hours and Weeks in the Theory of Labor Supply
(The Rand Corporation, Santa Monica, R-1787-HEW).
- _____ 1976b. A Multivariate Model of Labor Supply: Methodology
for Estimation (The Rand Corporation, Santa Monica, R-1869-HEW).
- _____ and M. Honig, 1976. The Effect of Social Security Benefits on
Labor Supply (The Hebrew University Department of Economics, Jerusalem,
Working Paper 88).
- Moffitt, R.A., 1977. Labor Supply, Kinked Budget Constraints, and the
Negative Income Tax (Mathematica Policy Research, Princeton,
Working Paper A-19).

Rea, S.A., Jr., 1974. Incentive Effects of Alternative Negative
Income Tax Plans, Journal of Public Economics 3, 237-249.

